

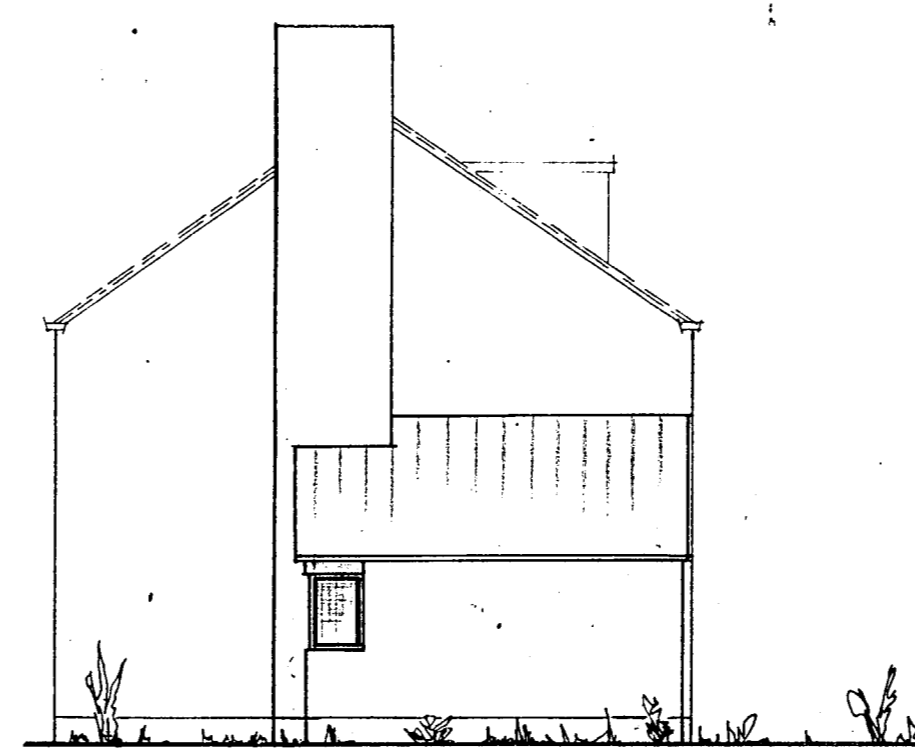

voorgevel



achtergevel



kopgevel

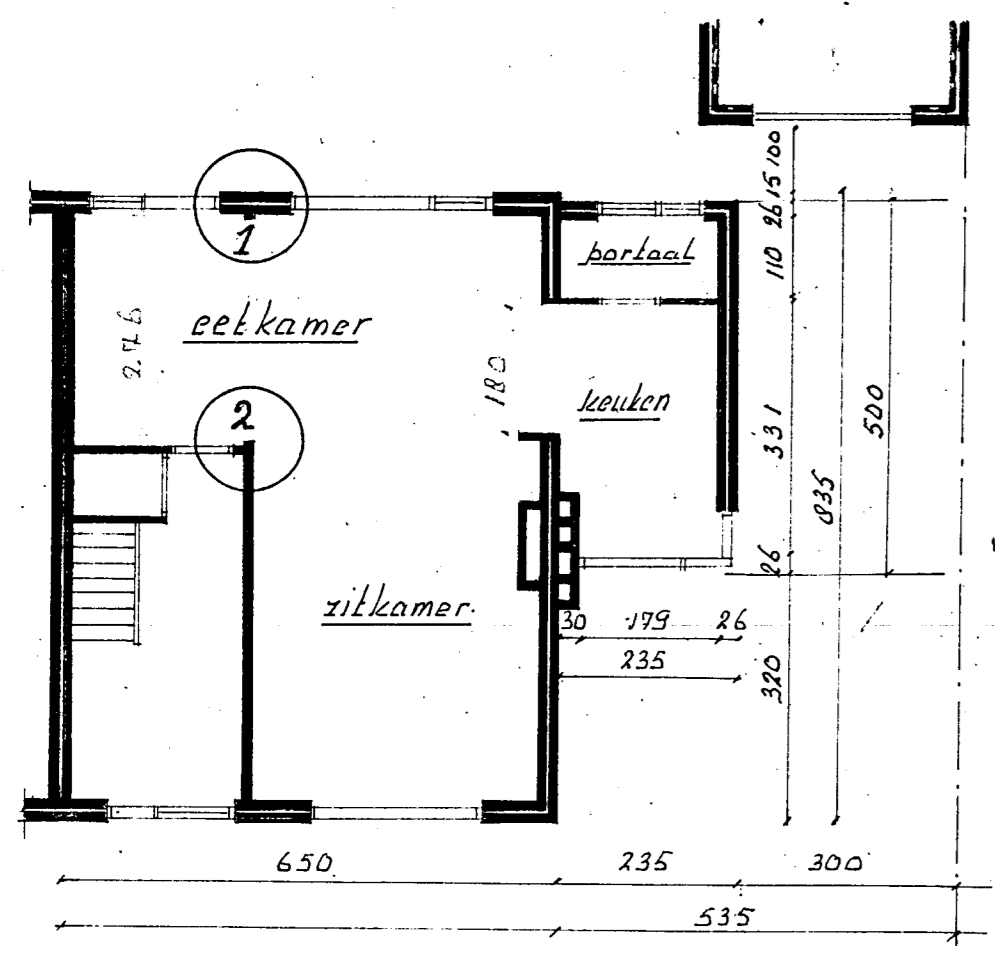
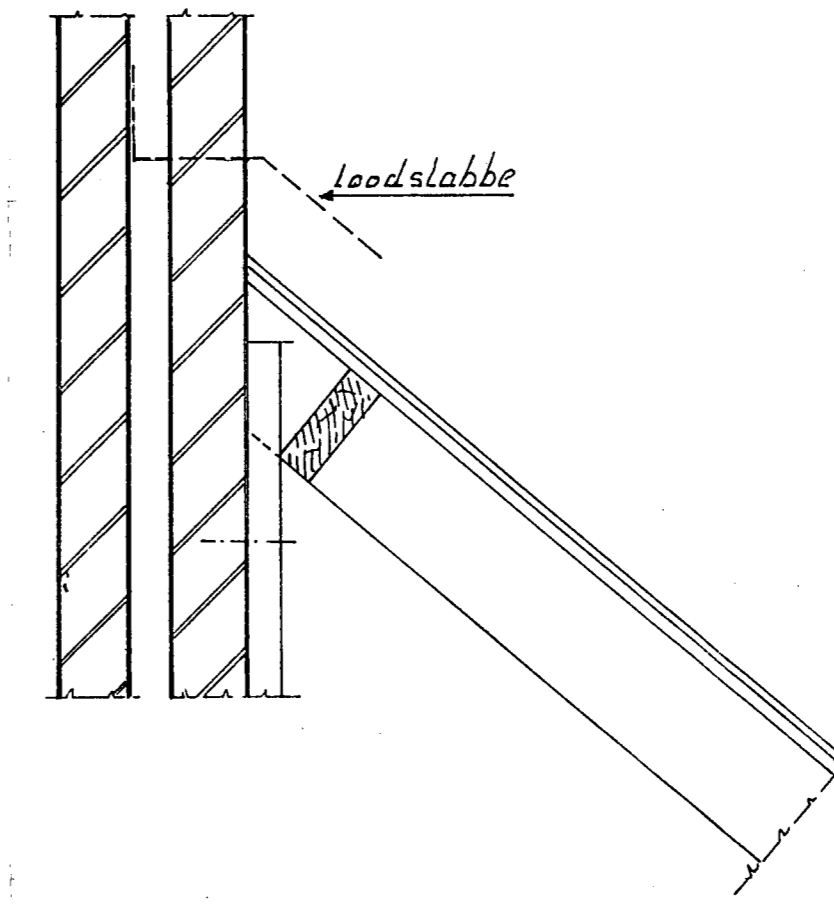

platte grond

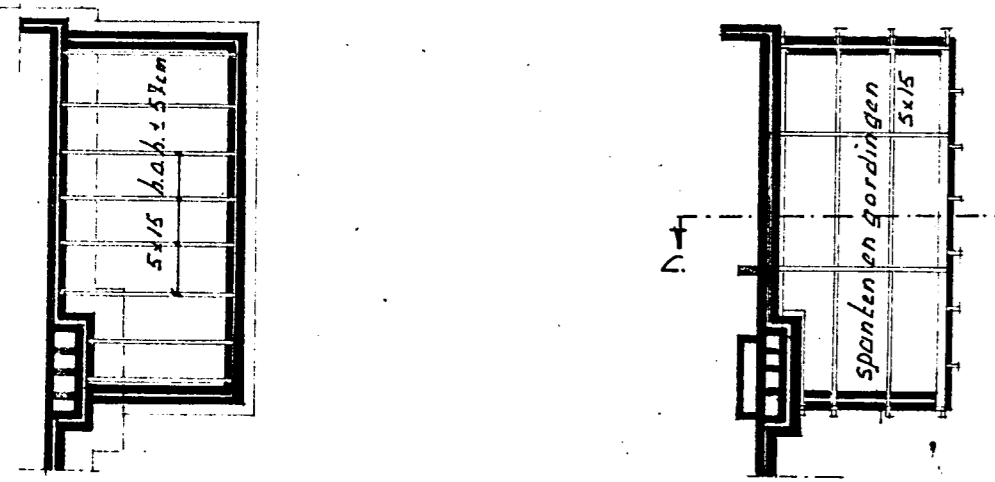

vloer balklaag

kopplan

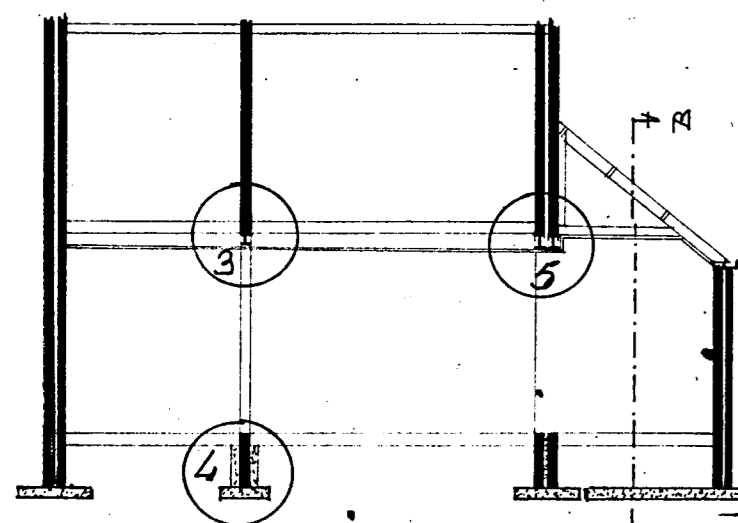

doorsnede

Behoort bij besluit van de Raad van Heemskerk B. en W. SEP. 1976 no. 177 Mij bekend. De Secretaris, Van Heemskerk,

INGEKOMEN 6 SEP. 1976

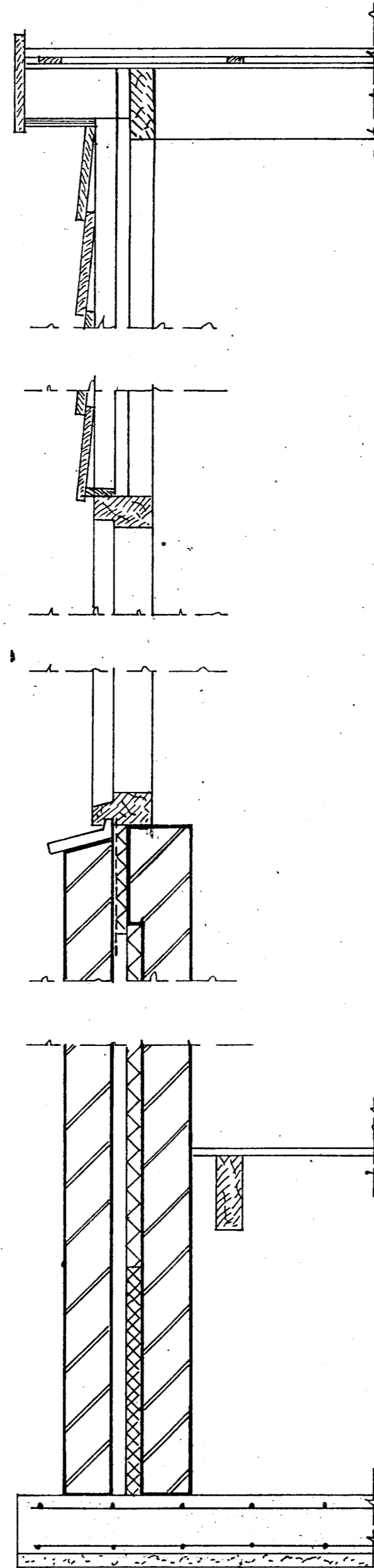

doorsnede A-B

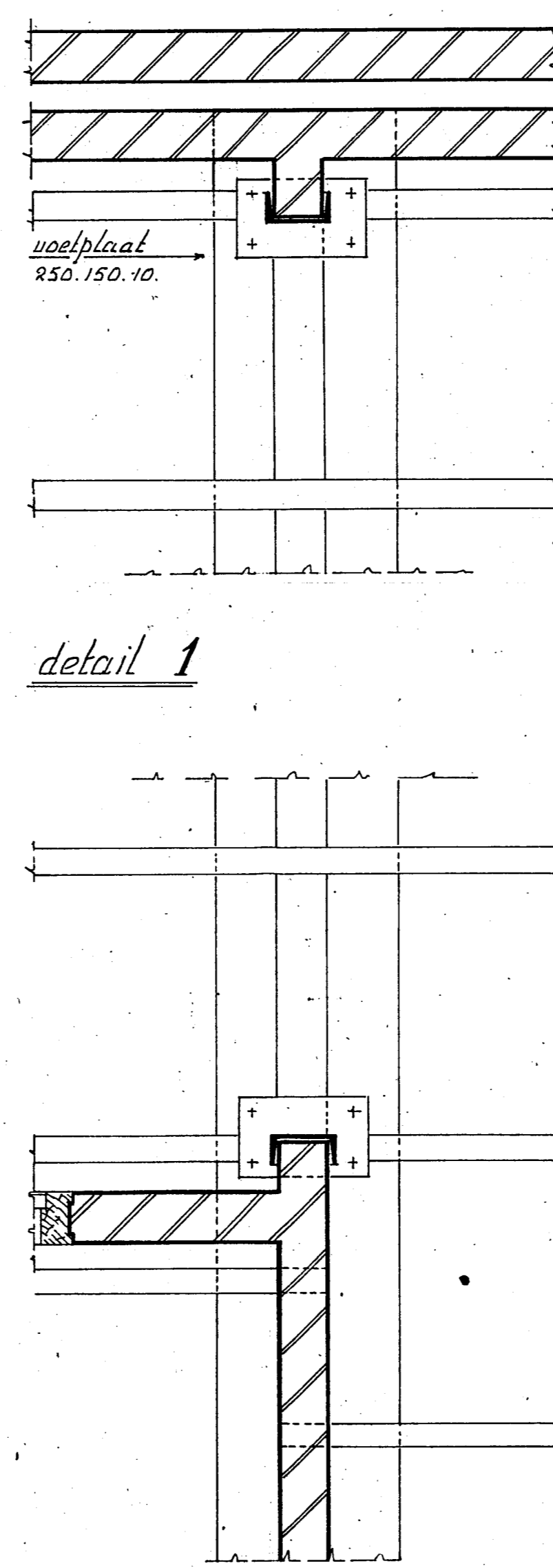

detail 1

detail 3

detail 2

detail 4

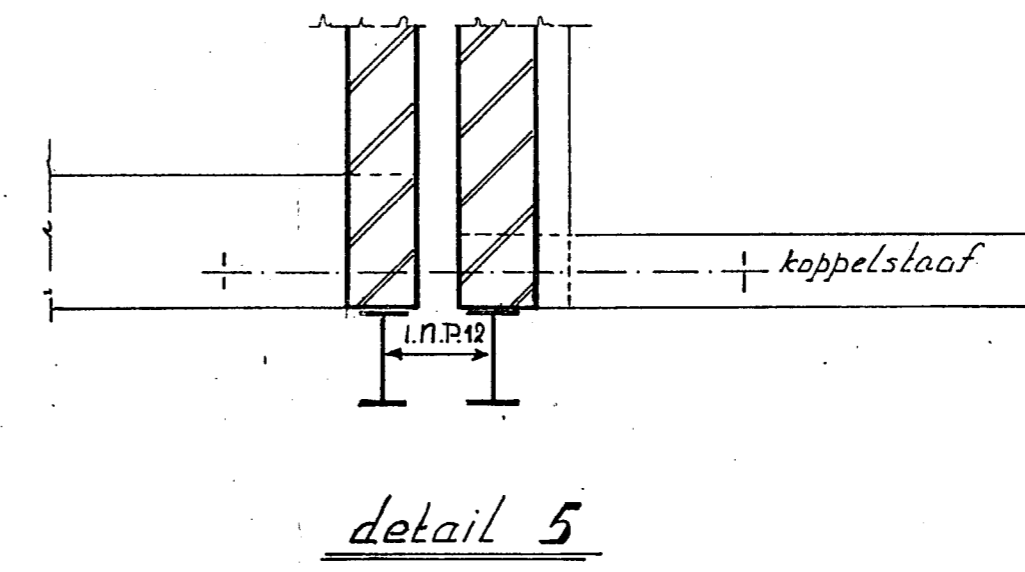

detail 5

staalwerk brandwerend bekleed
isolatie plafonds en spouw steenwal

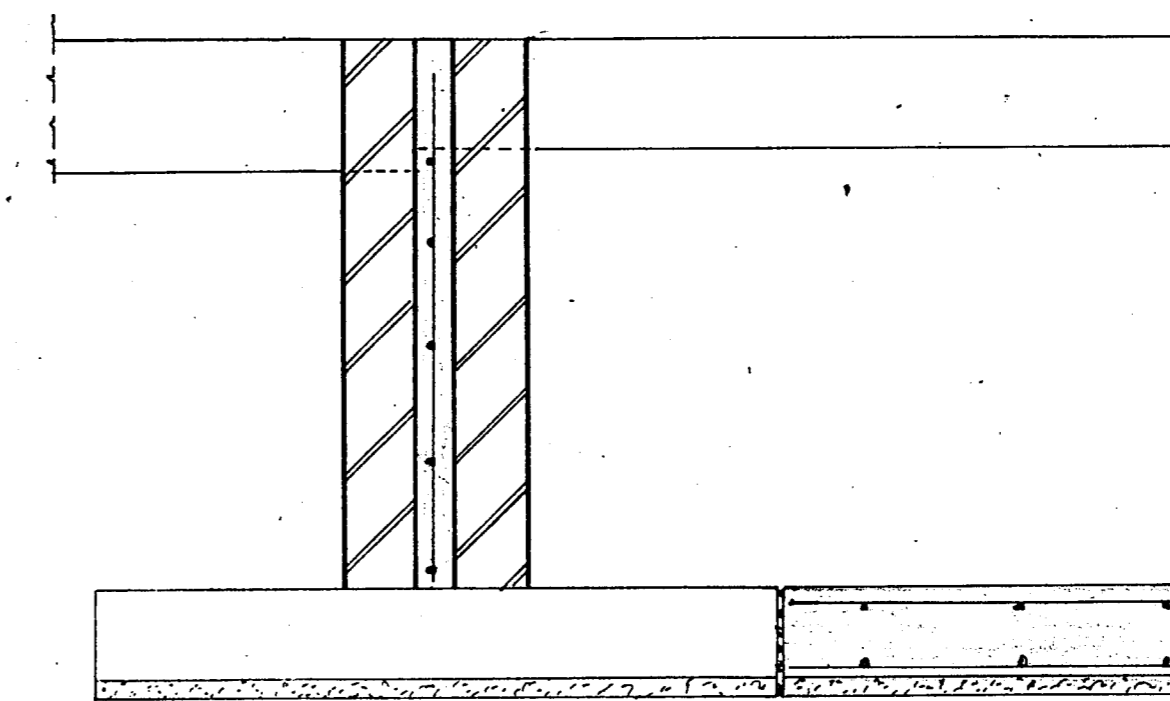
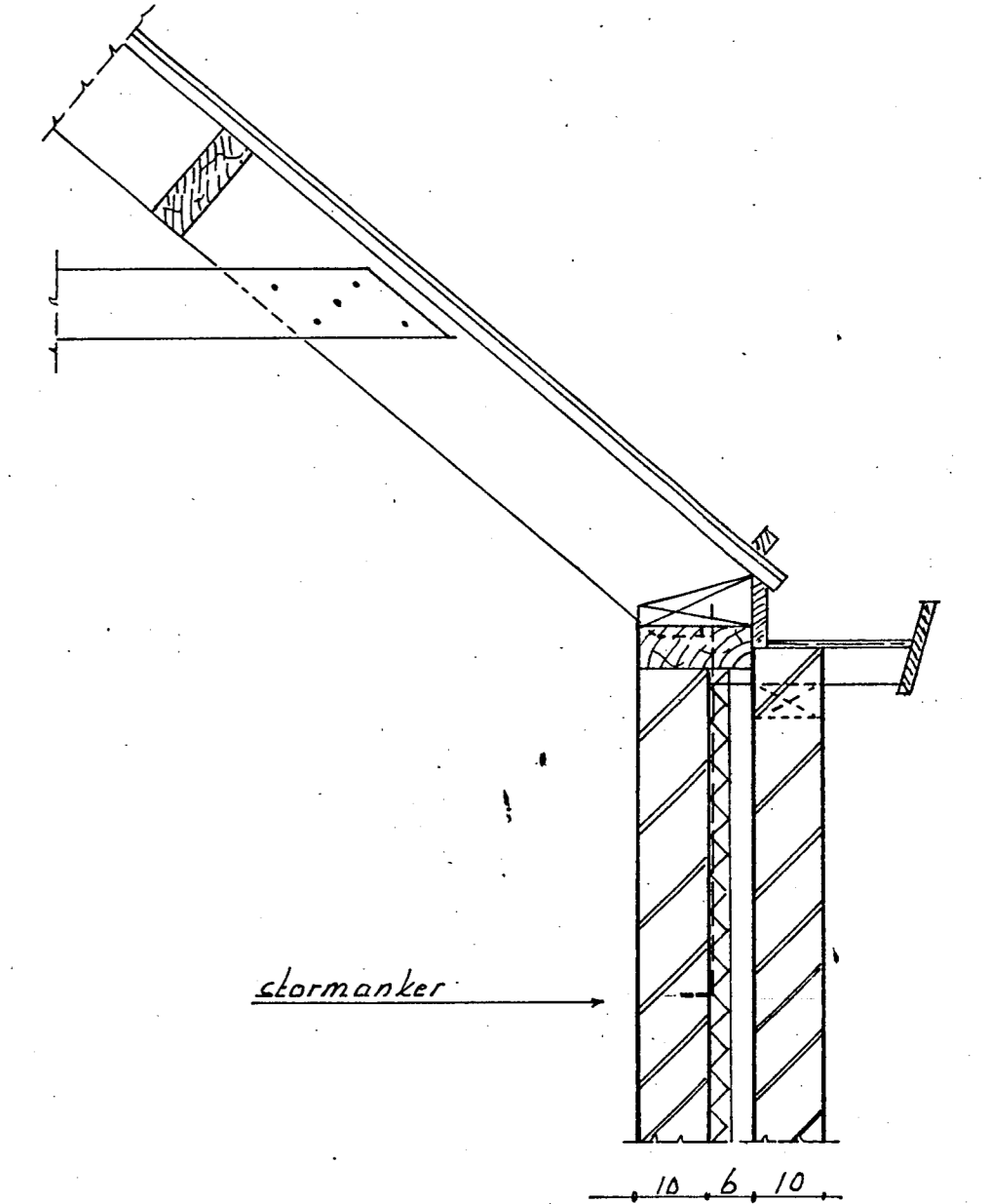

doorsnede C-D

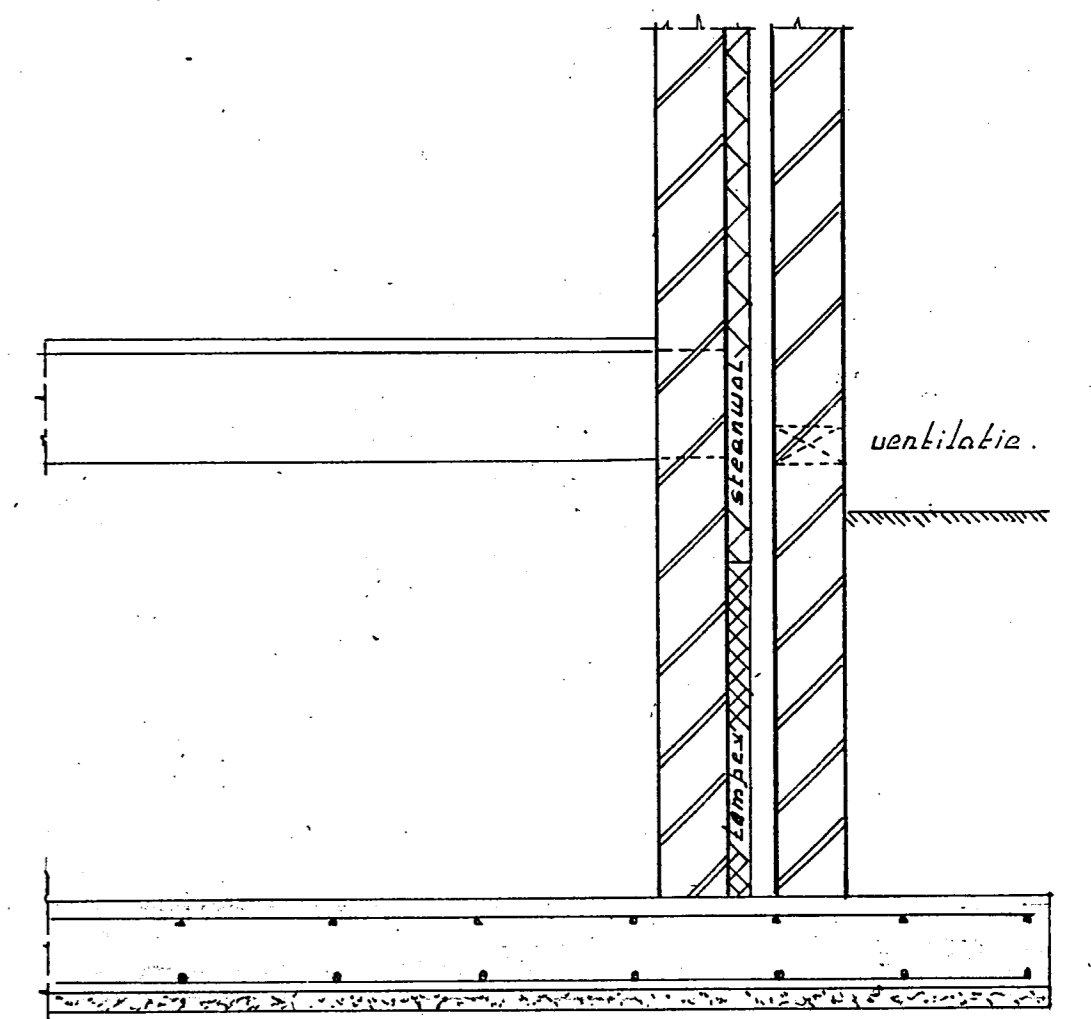

Plan voor het uitbreiden woonhuis van de heer Paap O.W. Grootstr. 2 te Heemskerk. schaal 1:10 en 1:100. get. 3-9-76 J.w.p.